



Eight Years MOS-IRS – Summary of Calibration Activities

Workshop on Inter-Comparison of Large Scale Optical and Infrared Sensors

**12 – 14 October 2004, ESA / ESTEC
Noordwijk, The Netherlands**

**Horst Schwarzer, DLR Optical Information Systems*)
Andreas Neumann, DLR Remote Sensing Technology Institute*)
Thomas Walzel, DLR Remote Sensing Technology Institute*)
*) 12489 Berlin, Rutherfordstr. 2, Germany**



Contents

1. Introduction
2. In-orbit calibrations (internal lamps, Sun and Moon)
3. Inter-comparisons with other missions (ground targets and derived geophysical products)
4. Conclusions



1. Introduction

- **The mission of the Modular Optoelectronic Scanner MOS on board IRS-P3 started in March 1996 and ended in May 2004**
 - eight successful years of operation in orbit
 - being the first imaging spectrometer in the Earth's orbit
- **4 methods of in-orbit calibration:**
 - internal lamps (4700 calibrations)
 - sun calibration with diffusers (70 calibrations)
 - ground target based calibration (36 calibrations)
 - Moon calibration (9 calibrations)
- **several inter - comparisons with SeaWiFS**
 - ground target Great Eastern Erg (GEE): surface reflectance
 - derived geophysical products: chlorophyll, sediment, aerosol optical thickness



**Performance data: Modular Optoelectronic Scanner MOS-IRS
(orbit: altitude 817 km; 10:45 AM equator crossing time, descending node,
sun synchronous polar)**

Parameter	MOS-A	MOS-B	MOS-C
Spectral range [nm]	755 - 768	408 - 1010	1550-1650
No. of channels	4	13	1
Centre wavelengths [nm]	756.7; 760.6; 763.5; 766.4	408; 443; 485; 520; 570; 615; 650; 685; 750; 815; 870; 945; 1010	1600
Spectral FWHM [nm]	1.4	10	93
Swath width [km]	187	200	192
No. of pixels	420	384	299
Pixel size x*y [km ²]	4.9 x 0.45	1.34 x 0.52	0.74 x 0.74
Measuring range L _{min} ...L _{max} [μWcm ⁻² nm ⁻¹ sr ⁻¹]	0.1 .. 40	0.2 .. 48	0.5 .. 8
Accuracy ΔL/L at L _{min} [%]	0.3	1.0	2.0
Dynamic range [bit]	16	16	16

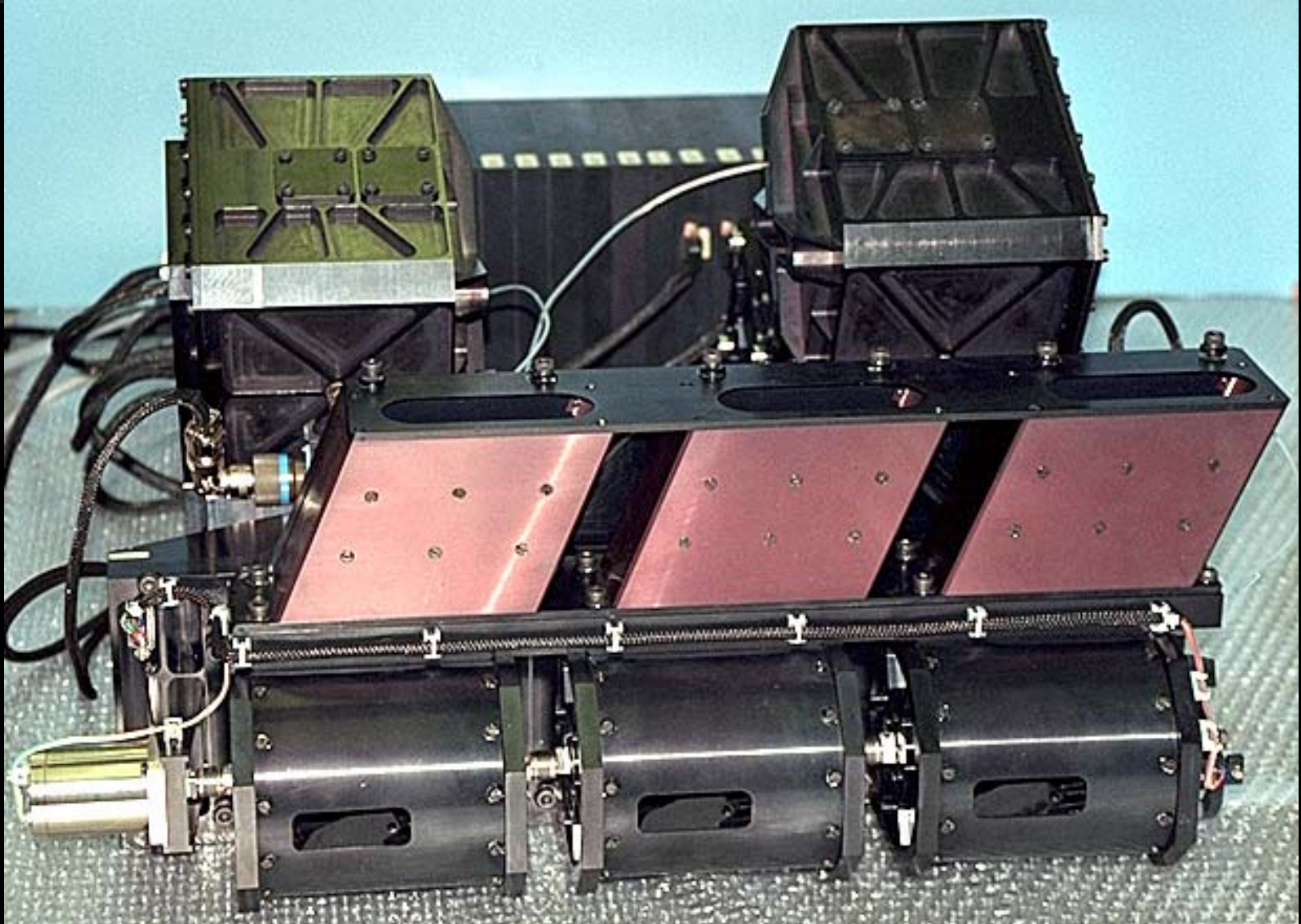

Optical Information Systems, Remote Sensing Technology Institute



MOS - B Optical design

- 1 quartz plate
- 2 quarter wave plate
- 3 objective "Tevidon" 1,4/25
- 4 shutter
- 5 glass prism
- 6 filter glass FB 120
- 7 mini lamp
- 8 entrance slit
0,041 mm x 6,140 mm
- 9 adjustment mirror
- 10 collimator "Pancolar" 1,8/80
- 11 grating 325 l/mm
- 12 imager "Pancolar" 2,8/120
- 13 filter glass RG 5
- 14 focal plane assembly
- 15 peltier cooler
- 16 sun diffuser
- 17 baffle
- 18 sun cal unit

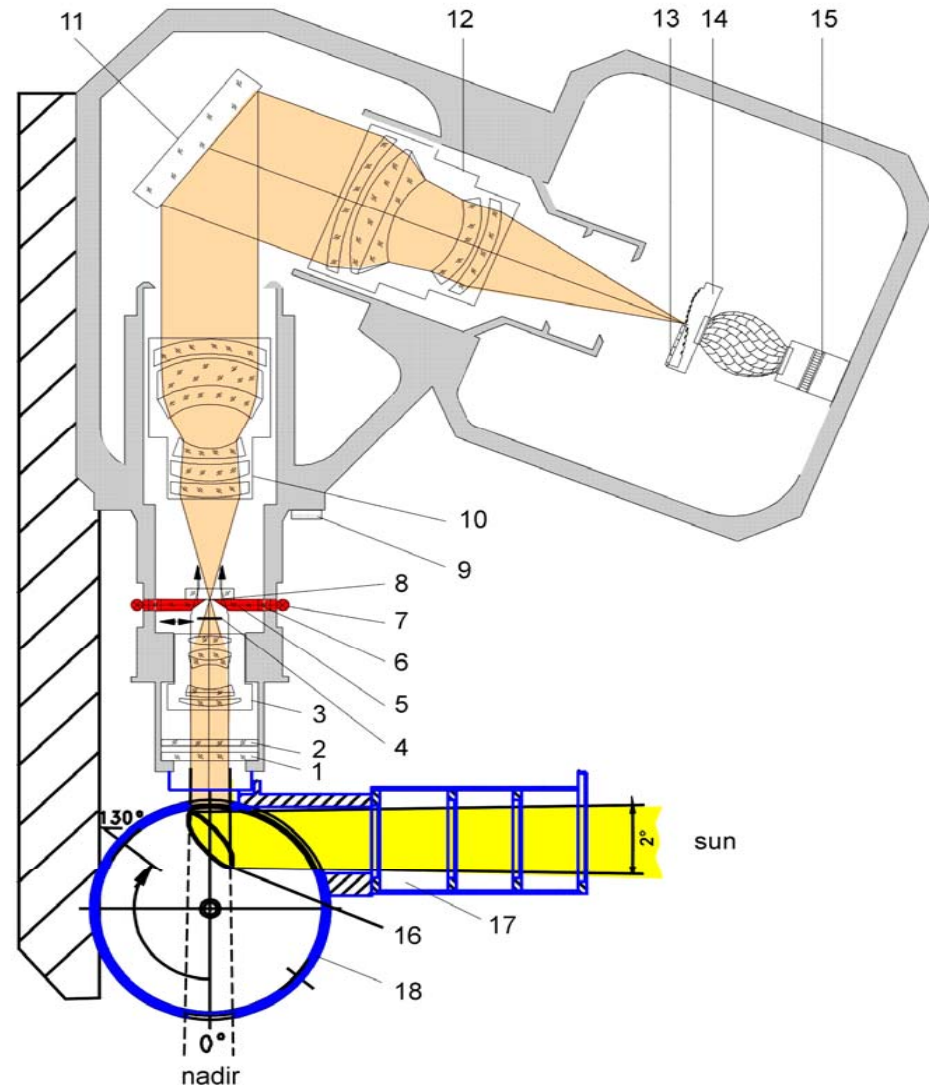



Nadir Position

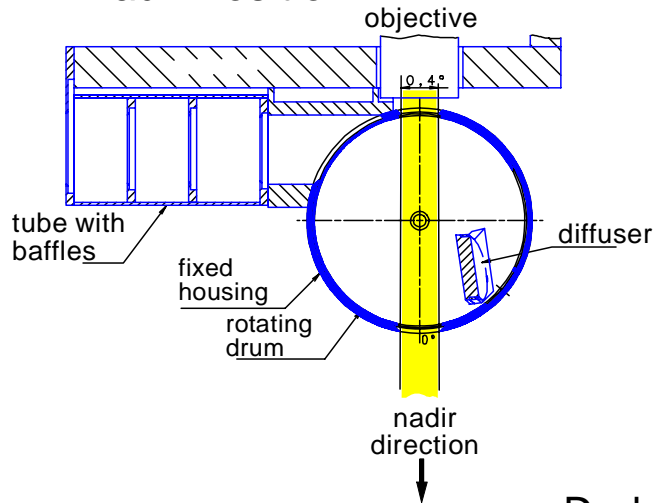

Sun Calibration Position

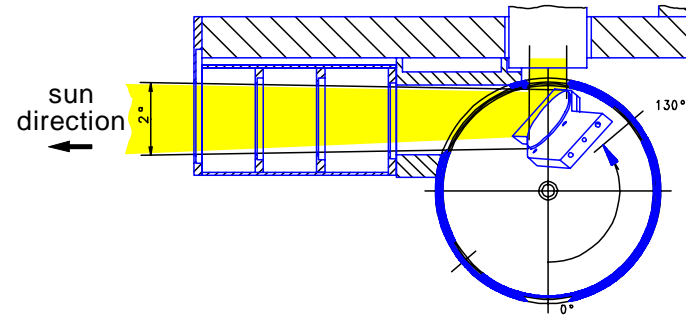

Dark Position

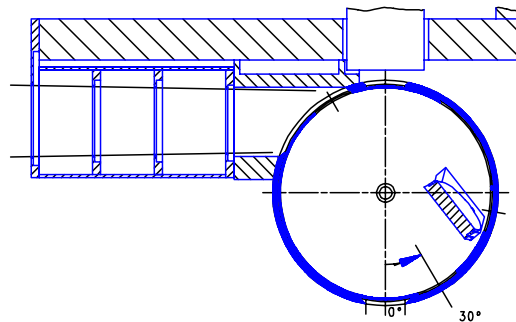



2. In-orbit calibrations

- **Internal lamps:**
Relative calibration of all pixels and checking the opto-electronical components of the spectrometer using two lamps at different levels
- **Sun calibration:**
Absolut and relative end to end calibration of all pixels using Spectralon diffusers in front of each instrument, 40° incidence angle, 50° viewing angle
- **Ground target based (vicarious) calibration:**
Relative end to end calibration of 60x60 pixels of water vapour unaffected channels over Algerian Great Eastern Erg (GEE) without atmospheric correction
- **Moon calibration:**
Checking the calibration relations between the channels in the O₂ absorption band and between MOS-A and MOS-B without atmospheric O₂ absorption effects



Internal lamp calibration

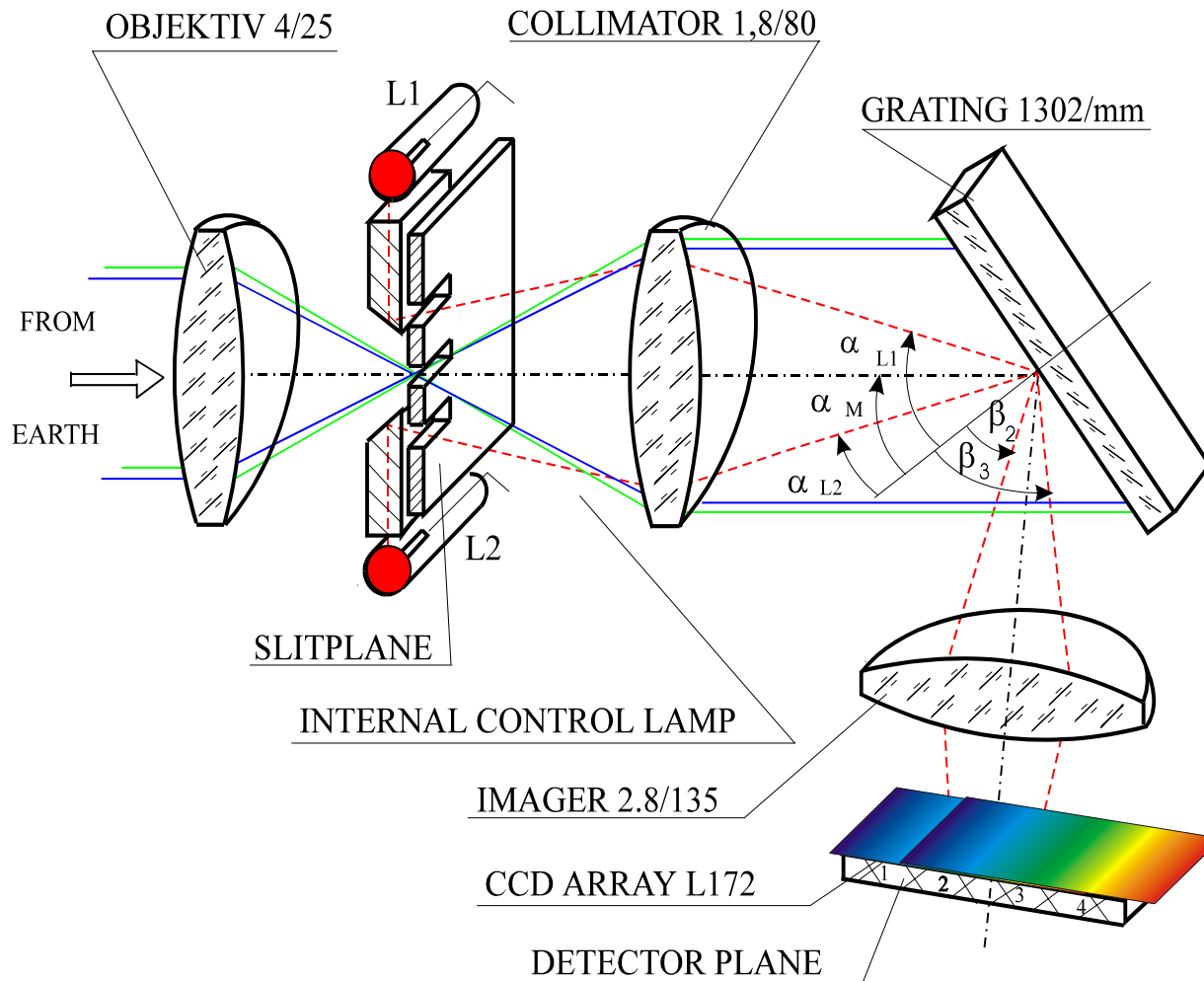



MOS - IRS; sun calibration optimal timing for SUN-CAL at limited recording time (51sec)

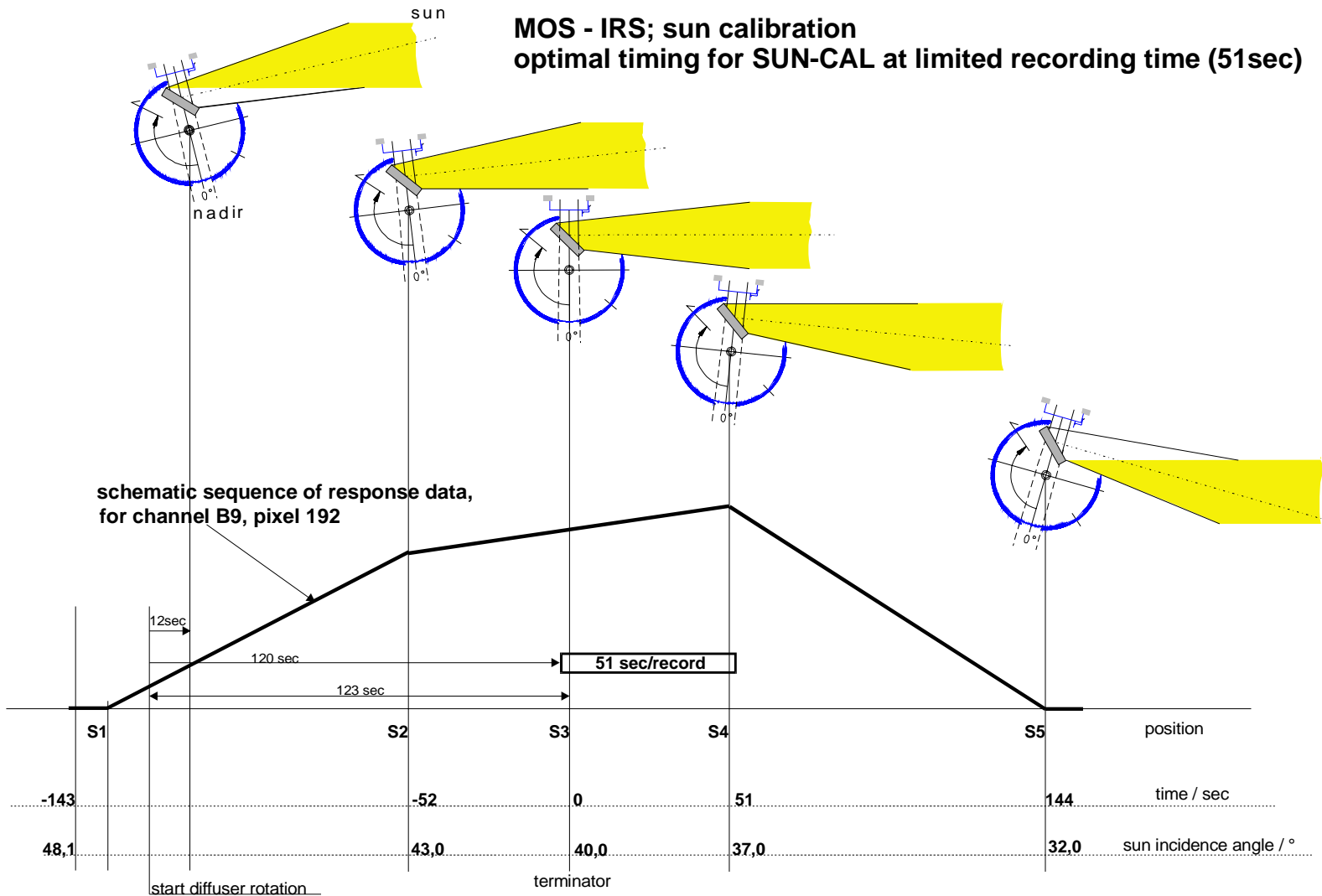

the sequence of response data is different for each channel and pixel



DLR

SeaWiFS



SeaWiFS

20.01.2002

26.04.2002

MOS

MOS

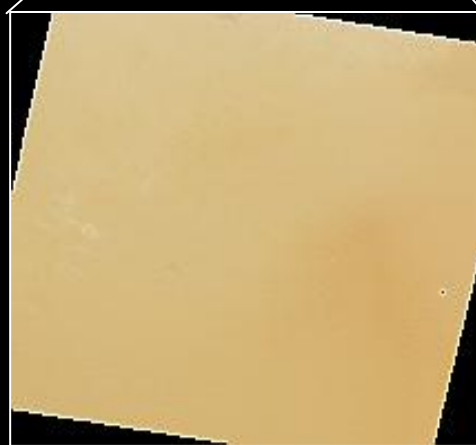
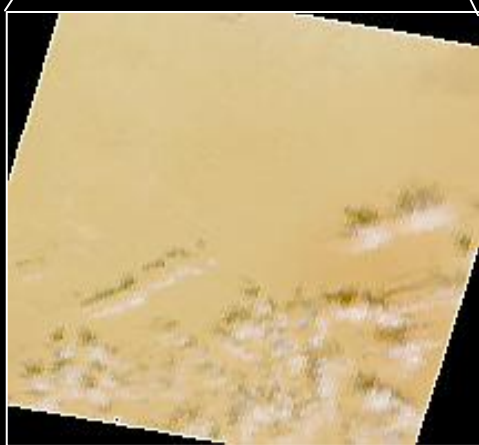
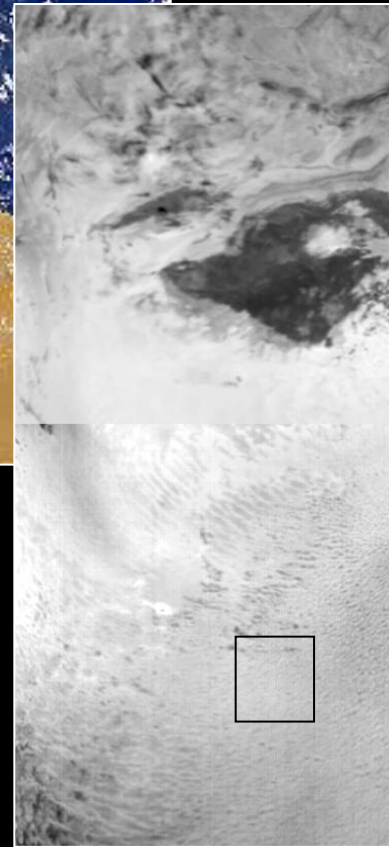
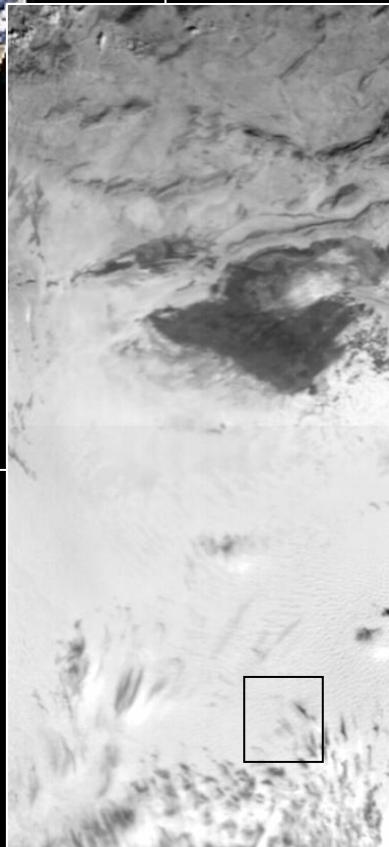
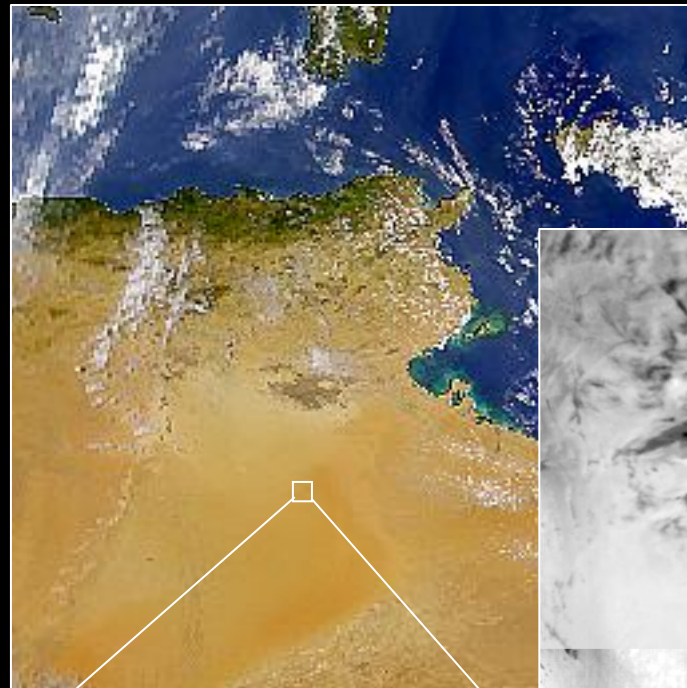
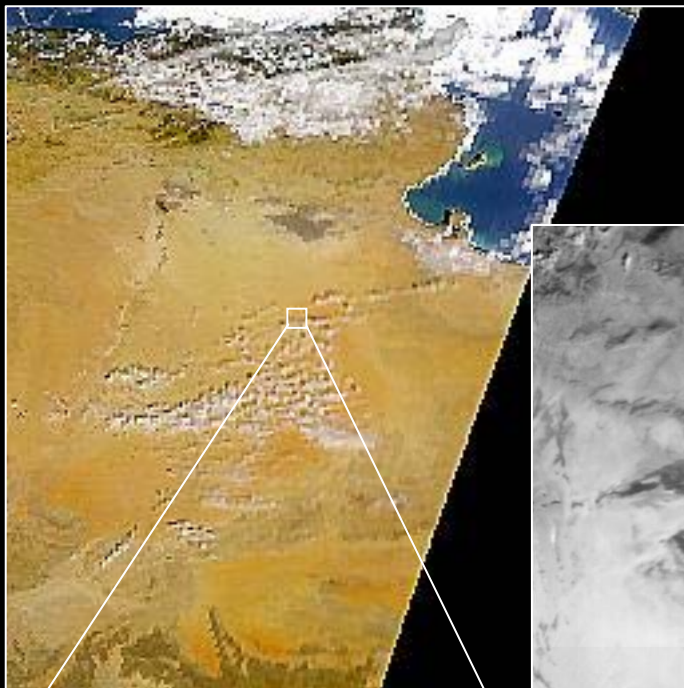



MOS - IRS - P3: In - Orbit - calibration, channel b01 (408nm), correction for T=15,00°C after failure of cooling

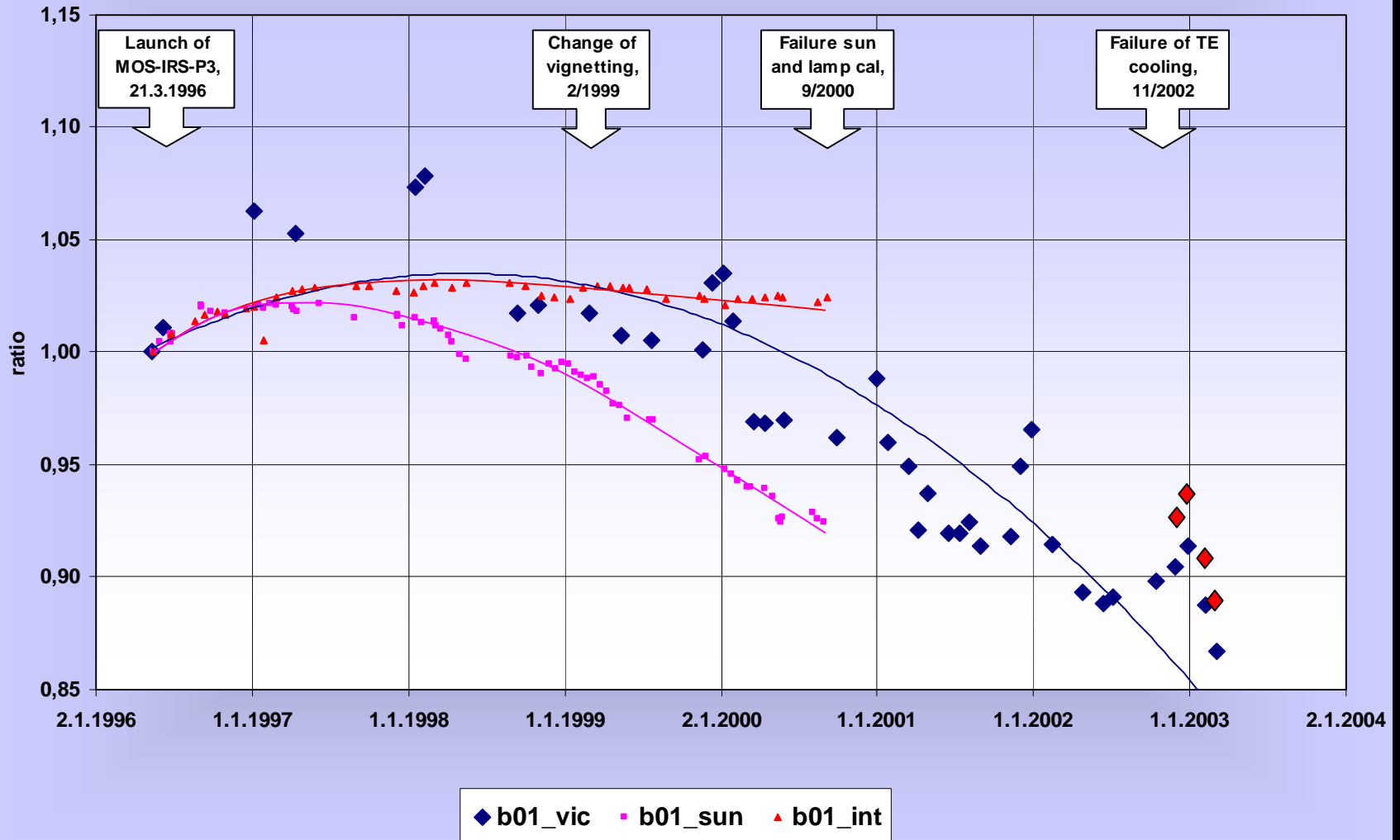



MOS - IRS - P3: In - Orbit - calibration, channel b08 (685nm), correction for T=15,00°C after failure of cooling

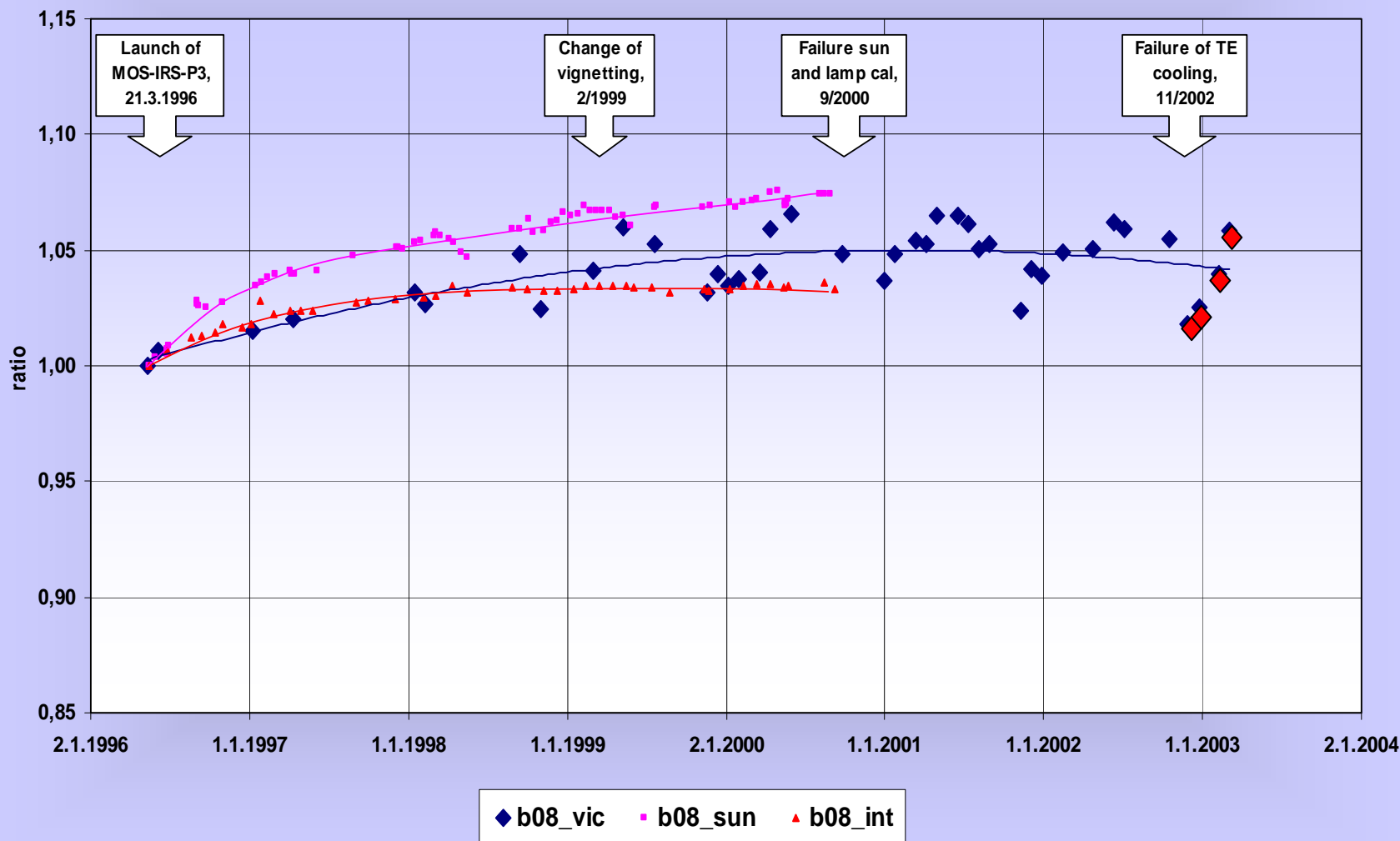



MOS - IRS - P3: In - Orbit - calibration, channel b13 (1010nm), correction for T=15,00°C after failure of cooling

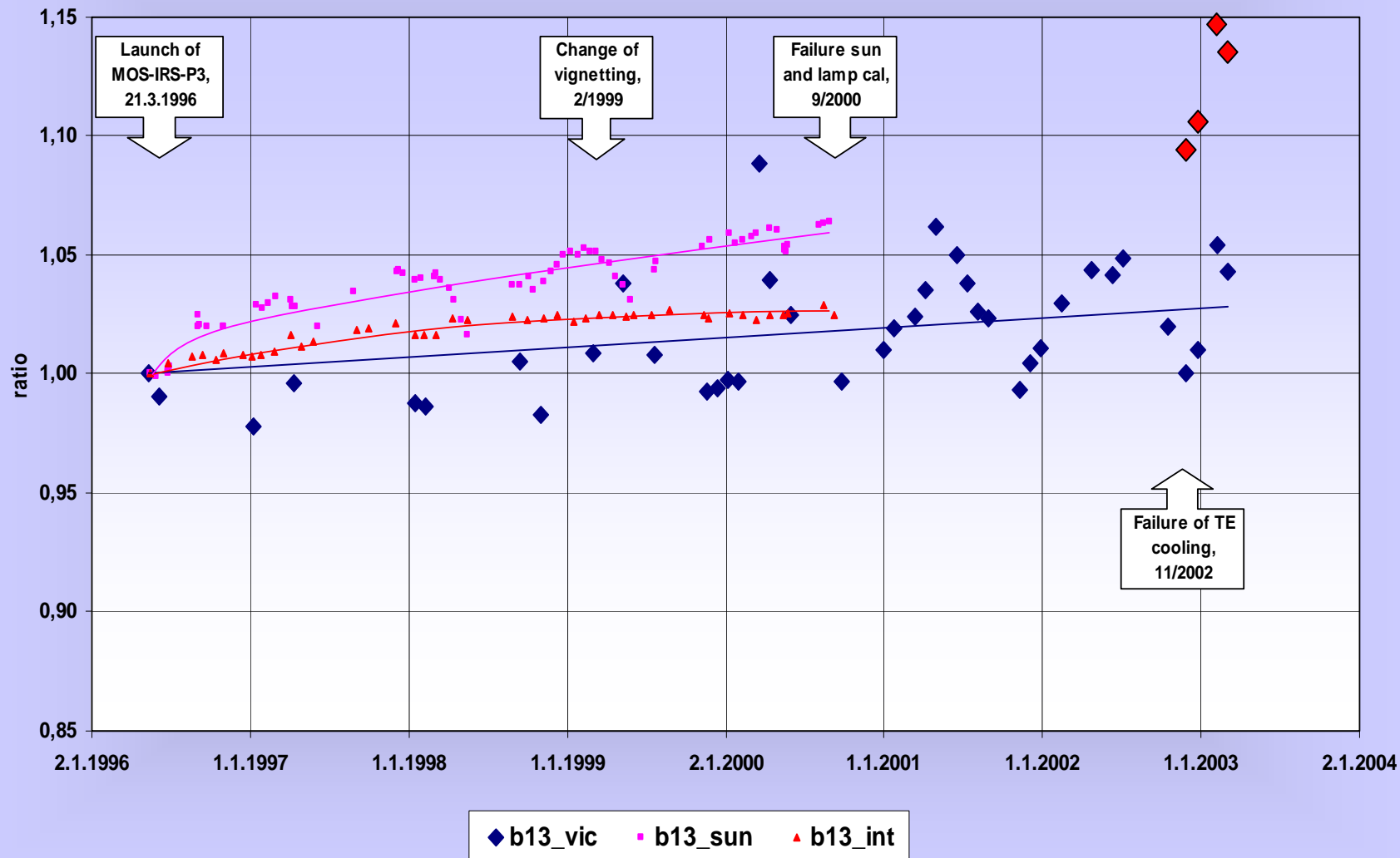



Relative spectral sensitivity $S(\lambda, T)$ of the CCD-line L172 versus wavelength λ and temperature T

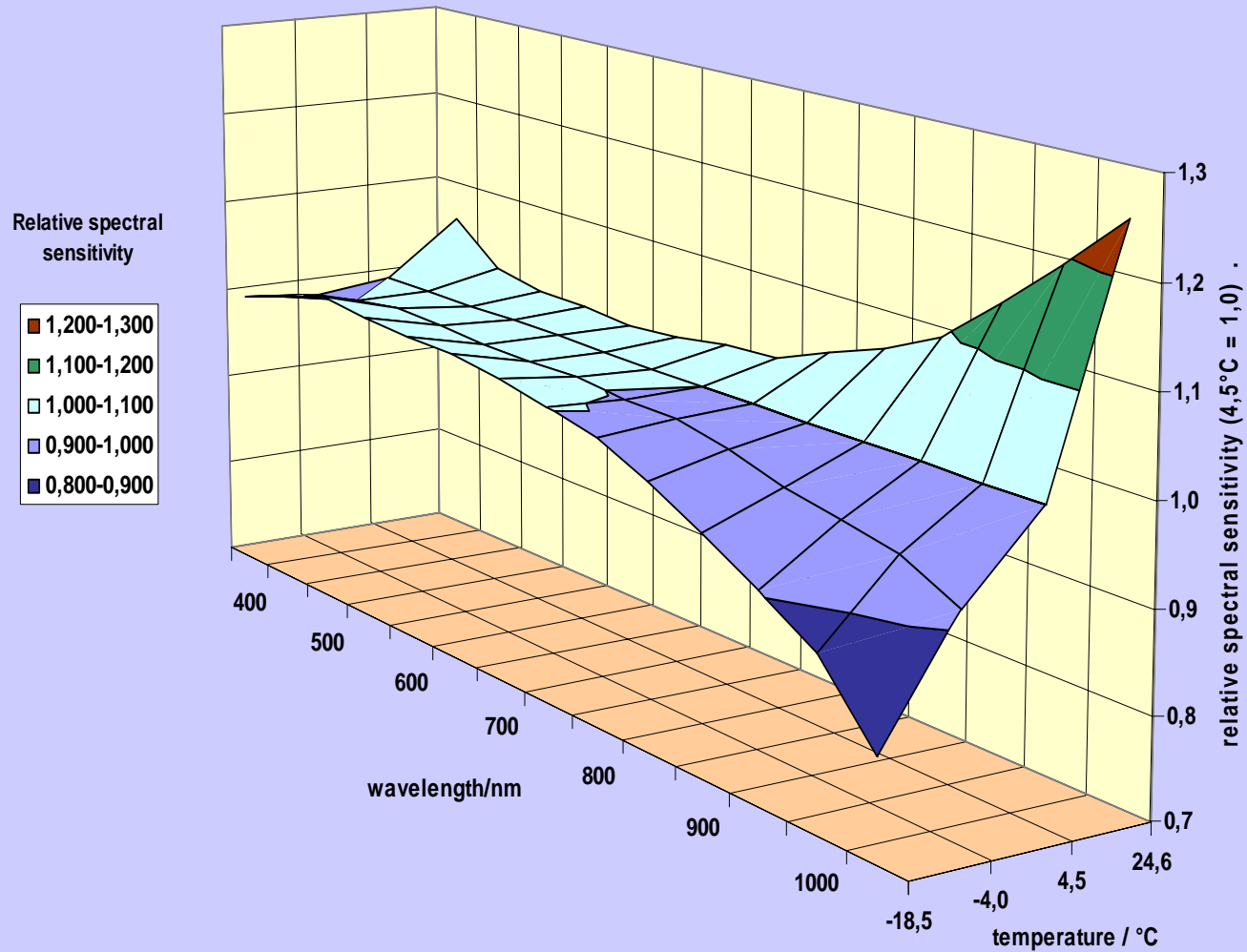



Relative change of MOS - IRS components during mission time





MOS Moon Calibration 27/08/1999

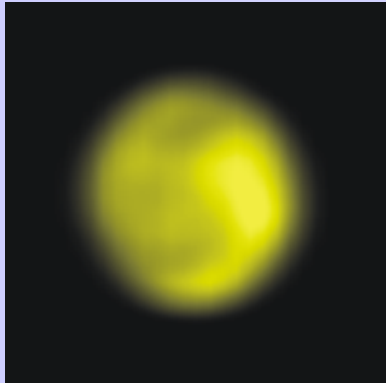

MOS-B Channel 9
(original)

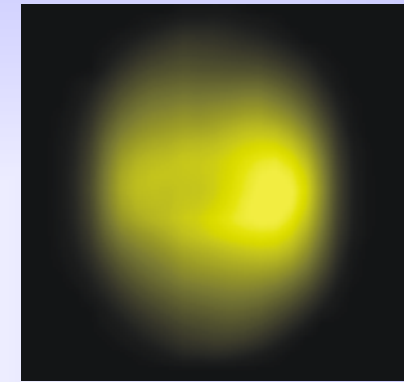
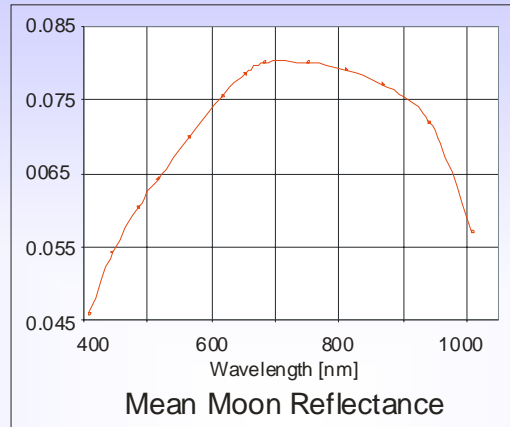

MOS-A Channel 1
(original)

Scatterplots of MOS-A channels Radiances in $\mu\text{W}/\text{cm}^2 \text{ nm sr}$

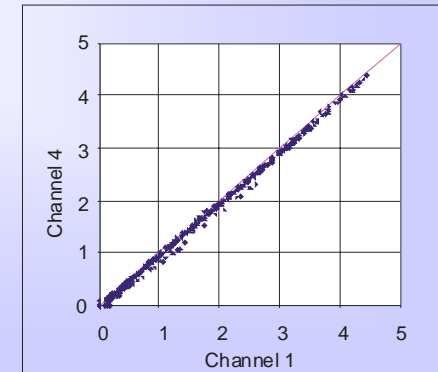
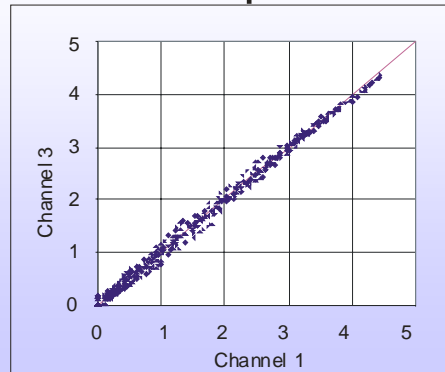
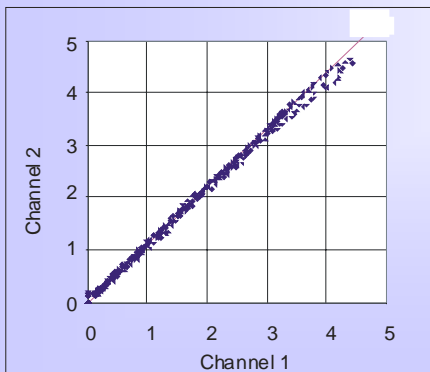



MOS-B Scatterplots of different records and same channels

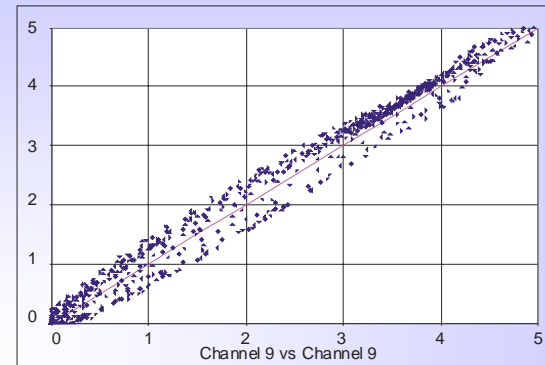
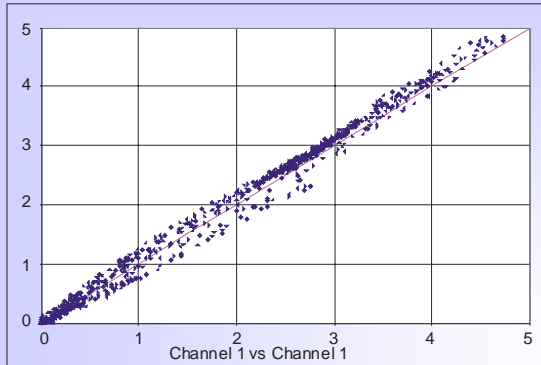

Scatterplots of geometrically matched original and filtered MOS-A and MOS-B at 750nm

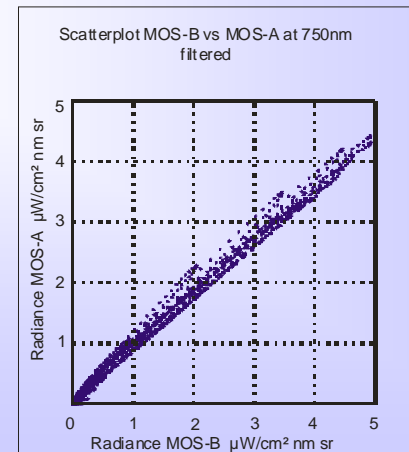
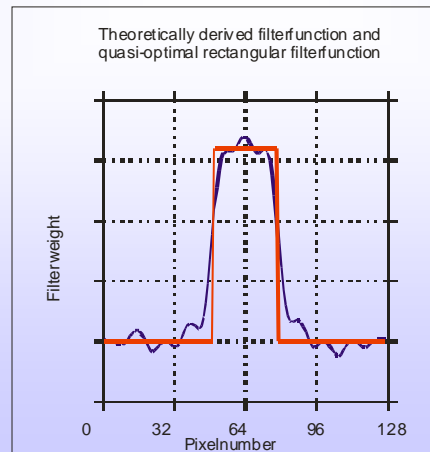
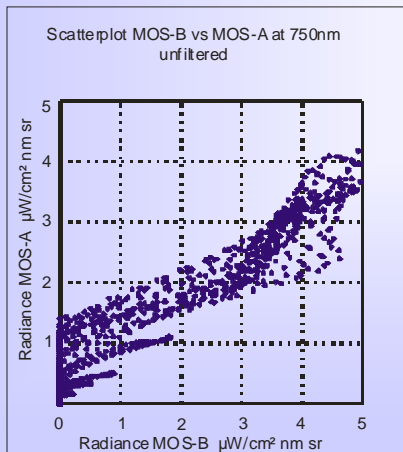



3. Inter-comparisons with other missions

- **Surface reflectance of ground target Great Eastern Erg (GEE):
derived from MOS and SeaWiFS data between 1997 and 2001**
- **Derived geophysical products:
chlorophyll concentration, sediment concentration and aerosol
optical thickness derived from MOS and SeaWiFS data over
different oceans and coastal zones**



MOS and SeaWiFS sensor description (MOS only SeaWiFS-like bands)

MOS-IRS / DLR		SeaWiFS / NASA	
Instrument spectral bands (for MOS only SeaWiFS-like bands)			
B01	412 \pm 5 nm	1	412 \pm 10 nm
B02	443 \pm 5 nm	2	443 \pm 10 nm
B03	485 \pm 5 nm	3	490 \pm 10 nm
B04	520 \pm 5 nm	4	510 \pm 10 nm
B05	570 \pm 5 nm	5	555 \pm 10 nm
B08	670 \pm 5 nm	6	670 \pm 10 nm
B09	750 \pm 5 nm	7	765 \pm 20 nm
B11	865 \pm 5 nm	8	865 \pm 20 nm
Mission characteristics			
Swath width 200 km (14.0°)		Swath width 2800 km (53.8 °)	
820 km sun synchronous orbit		705 km sun synchronous orbit	
0.52 x 0.52 km ² pixel size		1.1 x 1.1 km ² pixel size	
10:30 AM equator crossing, descending		12:20 AM equator crossing, descending	
24 days revisit time		1 day revisit time	



Relative variations of recalibrated MOS and SeaWiFS data of Great Eastern Erg test site for two selected channels

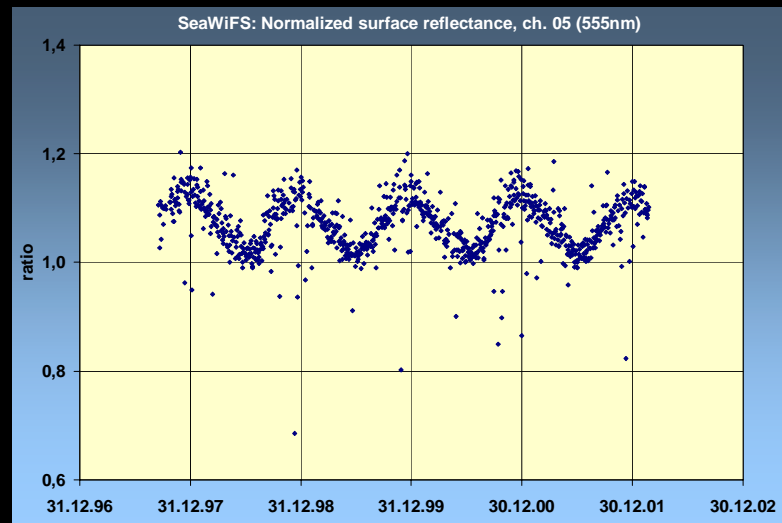
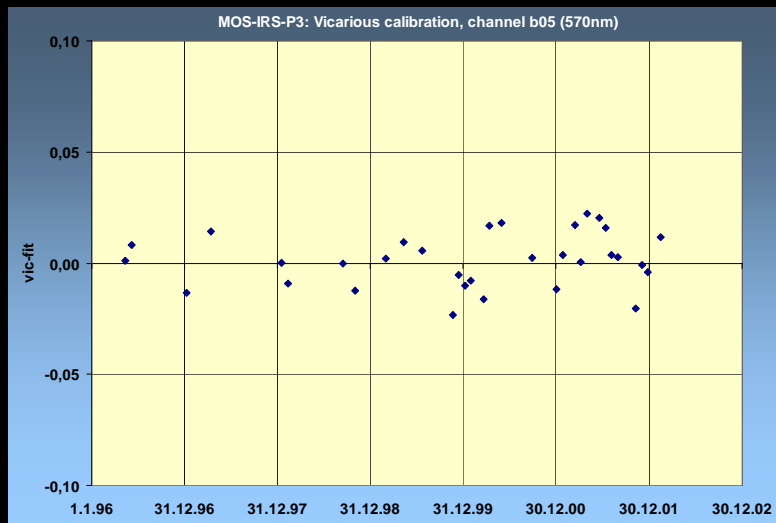
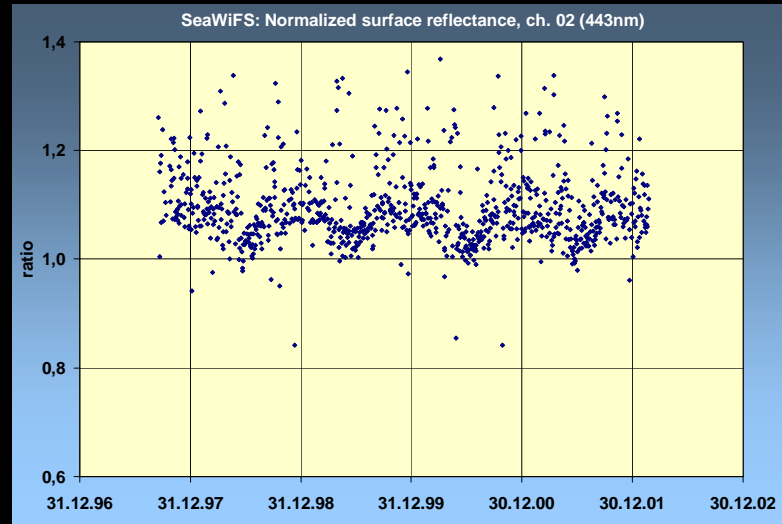
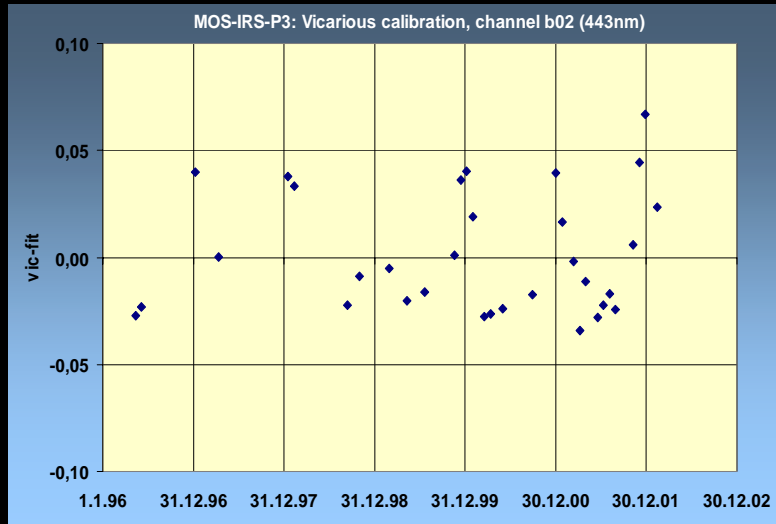



Spectral reflectance of Sahara sand derived from MOS, SeaWiFS and EGO

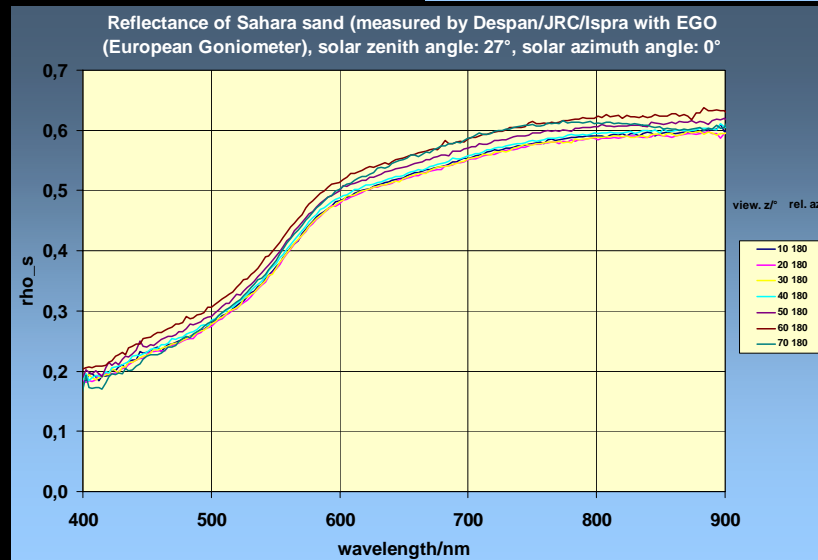
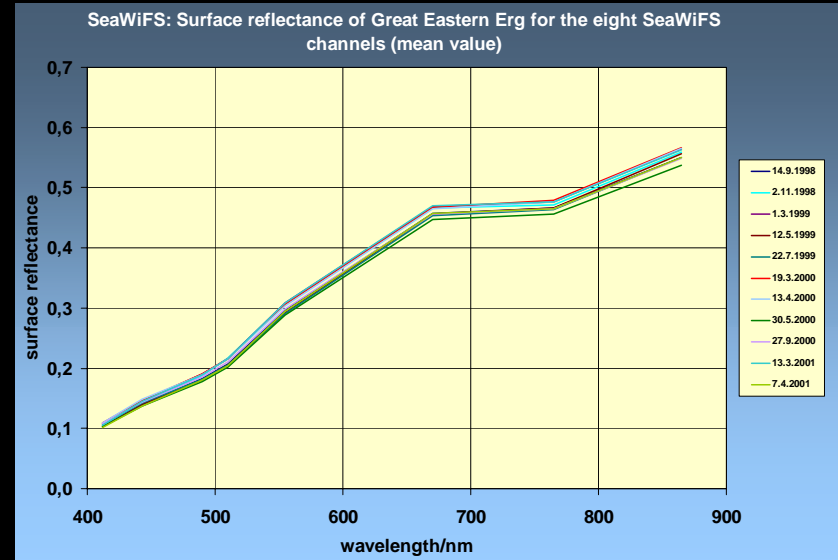
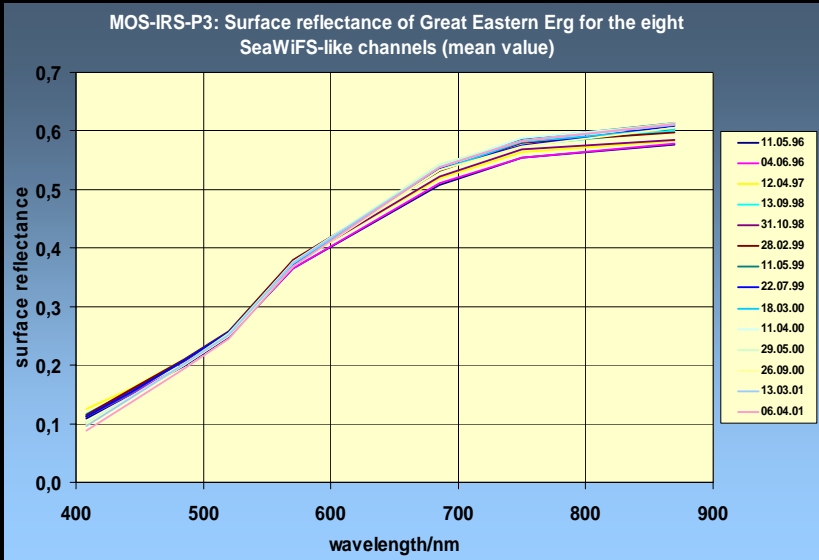



TOA PCI applied to MOS-IRS and SeaWiFS
 German Bight April 2, 1999

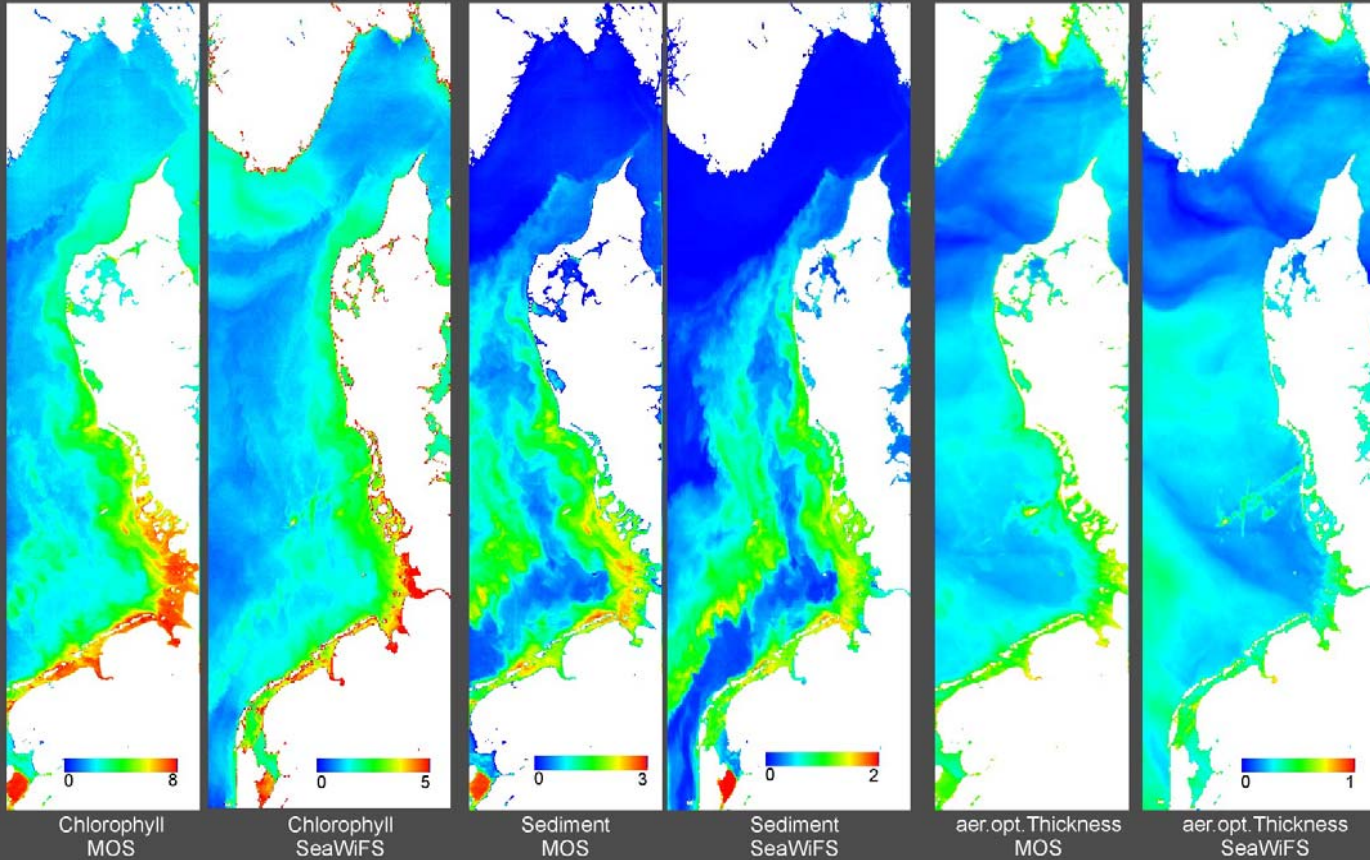



4. Conclusions

- **The precise lab calibration, adjustment and the comprehensive knowledge of the instruments behaviour under different environmental conditions was of utmost importance for the 8 years successful mission in orbit**
- **Using different methods of in-orbit calibration afforded to get continuously recalibration data in spite of some critical events such as the failure of power supply for lamp and sun calibration and of detector TE cooling**
- **This also gives the possibility of discrimination and identification of different sources and reasons for changes in the calibration data**
- **Accuracy of about 1...2% for the recalibration data is achievable**
- **Inter-comparisons between MOS and SeaWiFS showed a relative good consistency but gave also the chance for finding out some obscurities**